



Cambridge Assessment  
International Education

# Specimen Paper Answers

## Paper 4

### Cambridge IGCSE<sup>®</sup> / Cambridge IGCSE<sup>®</sup> (9–1) Mathematics 0580 / 0980

For examination from 2020



In order to help us develop the highest quality resources, we are undertaking a continuous programme of review; not only to measure the success of our resources but also to highlight areas for improvement and to identify new development needs.

We invite you to complete our survey by visiting the website below. Your comments on the quality and relevance of our resources are very important to us.

[www.surveymonkey.co.uk/r/GL6ZNPJB](http://www.surveymonkey.co.uk/r/GL6ZNPJB)

Would you like to become a Cambridge consultant and help us develop support materials?

Please follow the link below to register your interest.

[www.cambridgeinternational.org/cambridge-for/teachers/teacherconsultants/](http://www.cambridgeinternational.org/cambridge-for/teachers/teacherconsultants/)

©IGCSE is a registered trademark

Copyright © UCLES 2018

Cambridge Assessment International Education is part of the Cambridge Assessment Group. Cambridge Assessment is the brand name of the University of Cambridge Local Examinations Syndicate (UCLES), which itself is a department of the University of Cambridge.

UCLES retains the copyright on all its publications. Registered Centres are permitted to copy material from this booklet for their own internal use. However, we cannot give permission to Centres to photocopy any material that is acknowledged to a third party, even for internal use within a Centre.

---

# Contents

---

Contents .....	3
Introduction .....	4
Assessment overview .....	5
Question 1 .....	6
Question 2 .....	9
Question 3 .....	12
Question 4 .....	15
Question 5 .....	16
Question 6 .....	19
Question 7 .....	21
Question 8 .....	23
Question 9 .....	25
Question 10 .....	27
Question 11 .....	30

## Introduction

---

The main aim of this booklet is to exemplify standards for those teaching Cambridge IGCSE Mathematics 0580 and Cambridge IGCSE (9–1) Mathematics 0980 and to show examples of very good answers.

This booklet contains answers to Specimen Paper 4 (2020), which has been marked by a Cambridge examiner. Each answer is accompanied by a brief commentary explaining its strengths and weaknesses. These examiner comments indicate where and why marks were awarded and how answers could be improved

The Specimen Paper and mark scheme are available to download from the School Support Hub [www.cambridgeinternational.org/support](http://www.cambridgeinternational.org/support).

**2020 Specimen Paper 4**

**2020 Specimen Paper 4 Mark Scheme**

Past exam resources and other teacher support materials are also available on the School Support Hub.

## Assessment overview

All candidates take two papers.

Candidates who have studied the Core syllabus content, or who are expected to achieve a grade D (4) or below, should be entered for Paper 1 and Paper 3. These candidates will be eligible for grades C to G (1 to 5).

Candidates who have studied the Extended syllabus content and who are expected to achieve a grade C (5) or above should be entered for Paper 2 and Paper 4. These candidates will be eligible for grades A\* to E (3 to 9).

### Core candidates take:

<b>Paper 1 (Core)</b>	1 hour 35%
56 marks	
Short-answer questions	
Questions will be based on the Core curriculum	
Externally assessed	

### Extended candidates take:

<b>Paper 2 (Extended)</b>	1 hour 30 minutes 35%
70 marks	
Short-answer questions	
Questions will be based on the Extended curriculum	
Externally assessed	

### and:

<b>Paper 3 (Core)</b>	2 hours 65%
104 marks	
Structured questions	
Questions will be based on the Core curriculum	
Externally assessed	

### and:

<b>Paper 4 (Extended)</b>	2 hours 30 minutes 65%
130 marks	
Structured questions	
Questions will be based on the Extended curriculum	
Externally assessed	

- Candidates should have a scientific calculator for all papers.
- Three significant figures will be required in answers (or one decimal place for answers in degrees) except where otherwise stated.
- Candidates should use the value of  $\pi$  from their calculator or the value of 3.142.

## Question 1

### Specimen answer/s

- 1 (a) Kristian and Stephanie share some money in the ratio 3 : 2  
Kristian receives \$72.

- (i) Work out how much Stephanie receives.

$$72 \div 3 = 24$$

$$24 \times 2 = 48$$

$$\text{\$ } \underline{\quad 48 \quad} \quad [2]$$

- (ii) Kristian spends 45% of his \$72 on a computer game.

Calculate the price of the computer game.

$$45 \div 100 \times 72 = 32.4$$

$$\text{\$ } \underline{\quad 32.40 \quad} \quad [1]$$

- (iii) Kristian also buys a meal for \$8.40.

Calculate the fraction of the \$72 Kristian has left after buying the computer game and the meal.  
Give your answer in its lowest terms.

$$72 - 8.40 - 32.40 = 31.20$$

$$\frac{31.20}{72} = \frac{13}{30}$$

$$\underline{\quad \frac{13}{30} \quad} \quad [2]$$

- (iv) Stephanie buys a book in a sale for \$19.20.  
This sale price is after a reduction of 20%.

Calculate the original price of the book.

$$\text{Original price} = 100\%$$

$$\text{Reduced Price} = 80\% = 0.80$$

$$19.20 \div 0.80 = 24$$

$$\text{\$ } \underline{\quad 24 \quad} \quad [3]$$

- (b) Boris invests \$550 at a rate of 2% per year simple interest.

Calculate the value of the investment at the end of 10 years.

$$\text{Interest for one year } 550 \times 0.02 = 11$$

$$\text{Interest for ten years } = 10 \times 11 = 110$$

$$\text{Value of investment} = 550 + 110 = 660$$

$$\$ \text{ ..... } 660 \text{ ..... } [3]$$

- (c) Marlene invests \$550 at a rate of 1.9% per year compound interest.

Calculate the value of the investment at the end of 10 years.

$$550 \times 1.019^{10} = 663.9028448$$

$$\$ \text{ ..... } 663.90 \text{ ..... } [2]$$

- (d) Hans invests \$550 at a rate of  $x\%$  per year compound interest.

At the end of 10 years, the value of the investment is \$638.30, correct to the nearest cent.

Find the value of  $x$ .

$$550 \left( 1 + \frac{x}{100} \right)^{10} = 638.30$$

$$\left( 1 + \frac{x}{100} \right)^{10} = 638.30 \div 550$$

$$1 + \frac{x}{100} = \sqrt[10]{\frac{638.30}{550}}$$

$$x = 100 \times \left( \sqrt[10]{\frac{638.30}{550}} - 1 \right)$$

$$x = 1.500040489$$

$$x = \text{ ..... } 1.50 \text{ ..... } [3]$$

## Examiner comment

### Question 1

- (a) (i) The key here is to match the 3 parts in the ratio for Kristian with the \$72 and then to find 1 part by division by 3. Stephanie receives 2 parts in the ratio so the final step is to multiply by 2. The answer is exact. A Method mark is available for showing 72 divided by 3. **2/2**
- (ii) Use a calculator to find 45%. 45 divided by 100 times \$72 = £32.4. As this is money, ensure a zero is added to the answer so that it is in dollars and cents. **1/1**
- (iii) First stage is to consider how much Kristian has spent altogether. He spends \$32.40 on the computer game and \$8.40 on the meal. Then we need to find the amount remaining by subtracting these values from \$72. As we are asked what fraction he has left, we must write the amount he has left as a fraction of \$72. The question also asks that this is written in its simplest form so using the fraction key on the calculator, this reduces to  $\frac{13}{30}$ . The mark scheme allows a Method mark for the unsimplified fraction. **2/2**
- (iv) Finding the original price is an indication that this is a reverse percentage calculation. Treat the original amount as 100%. The first step is to find the percentage that the sale price is of the original by subtracting 20% from 100%. Then convert this to a multiplier by dividing by 100 = 0.8. Then divide the sale price by the multiplier to arrive back at the original price. The answer is exactly \$24 which is fine as the answer without zeros. Two Method marks are available for a complete correct method, e.g. dividing the sale price by 0.8. One Method mark is earned for associating the sale price with 80%. **3/3**
- (b) Candidates need to understand the difference between simple and compound interest. With simple interest, the interest for one year is calculated and then multiplied by the number of years. The interest is the same for each year. The final stage is to add the original investment to the interest to earn the 3 marks for the question. Two Method marks are available here for a full correct method. One Method mark is earned for a correct method to find the total interest. **3/3**
- (c) This part asks for compound interest. This is where the interest is added to the investment each year before the new interest is calculated. The best way to tackle this is to find the multiplier for one year  $(100 + 1.9) \div 100$  and then use a power to repeat the 'multiplier' for the 10 years as shown. Some candidates use a longer method of repeated steps by finding the interest for each year and then adding, but this is not recommended and leads to inaccurate answers. As this is a money calculation, the final answer should be rounded to 2 decimal places to earn the two marks for the question. A Method mark is available for a fully correct method e.g.  $550 \times 1.019^{10}$ . **2/2**
- (d) This part involves a reverse calculation. With challenging questions like this, it is important to make an initial statement (line 1) involving the rate of compound interest,  $x\%$ , to work backwards from. Each step can then be reversed to arrive at  $x$ . It is important to consider the order of operations when reversing and not to round any intermediate calculations. Keep the full value from each stage on calculators until the final step. The final answer should be rounded to 3 significant figures to earn the 3 marks for the question. **3/3**

**Total mark awarded = 16 out of 16**



## Question 2

### Specimen answer/s

- 2 (a) 200 students estimate the volume,  $V \text{ m}^3$ , of a classroom.  
The cumulative frequency diagram shows their results.

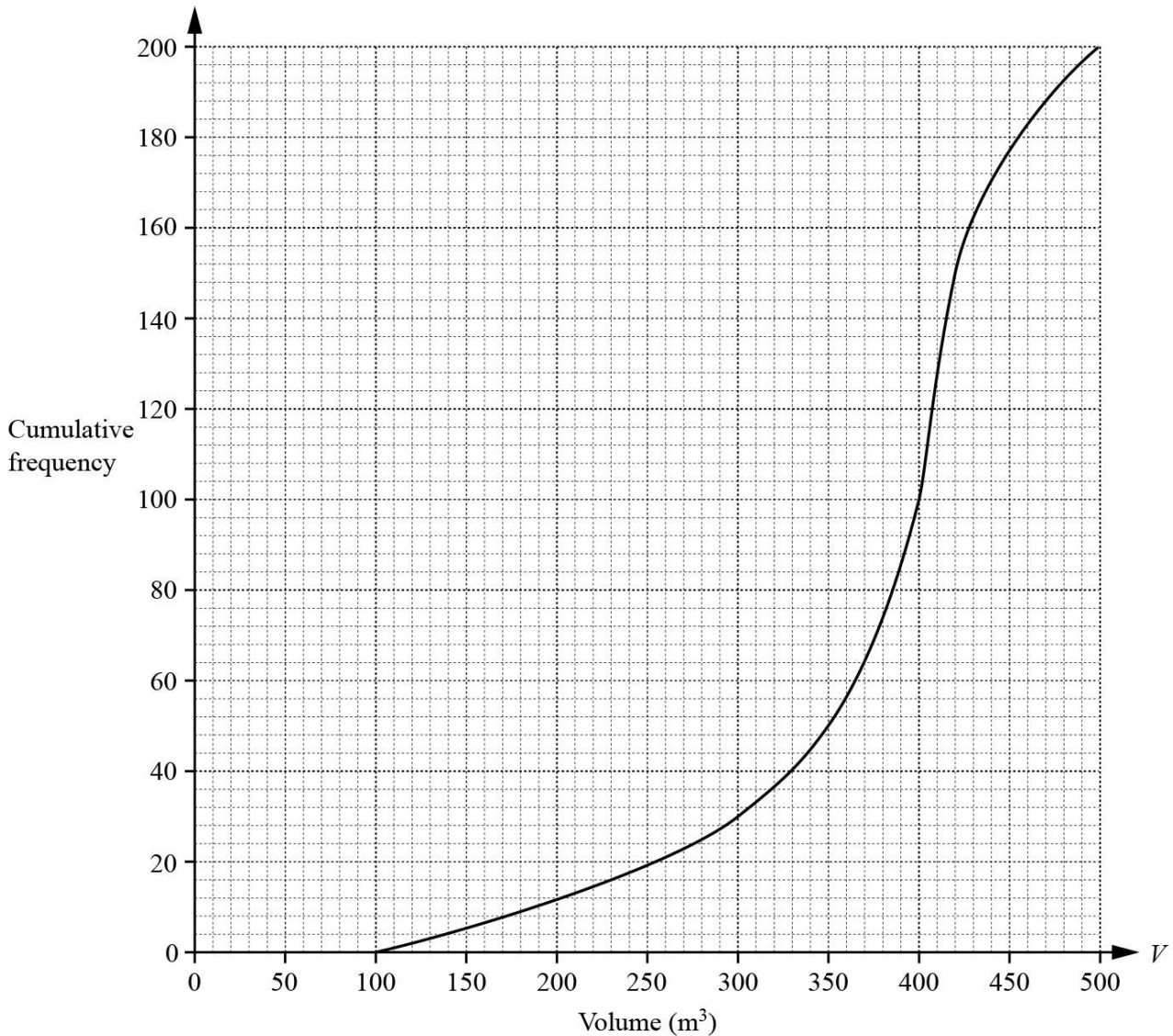

Use the graph to find an estimate of

- (i) the median, ..... 400 .....  $\text{m}^3$  [1]
- (ii) the interquartile range,  
 UQ = 420      LQ = 350, 420–350 ..... 70 .....  $\text{m}^3$  [2]
- (iii) the 60th percentile, ..... 405 .....  $\text{m}^3$  [1]
- (iv) the number of students who estimate that the volume is greater than  $300 \text{ m}^3$ .  
 300 cubic metres or less = 30 students,  $200 - 30 = 170$  ..... 170 ..... [2]

- (b) The 200 students also estimate the total area,  $A \text{ m}^2$ , of the windows in the classroom. The table shows their results.

Area ( $A \text{ m}^2$ )	$20 < A \leq 60$	$60 < A \leq 100$	$100 < A \leq 150$	$150 < A \leq 250$
Frequency	32	64	80	24

- (i) Calculate an estimate of the mean.  
You must show all your working.

Mid interval values 40, 80, 125 and 200

$$32 \times 40 + 64 \times 80 + 80 \times 125 + 24 \times 200 = 21\,200$$

$$21\,200 \div 200 = 106$$

$$\dots\dots\dots 106 \dots\dots\dots \text{m}^2 \text{ [4]}$$

- (ii) Complete the histogram to show the information in the table.

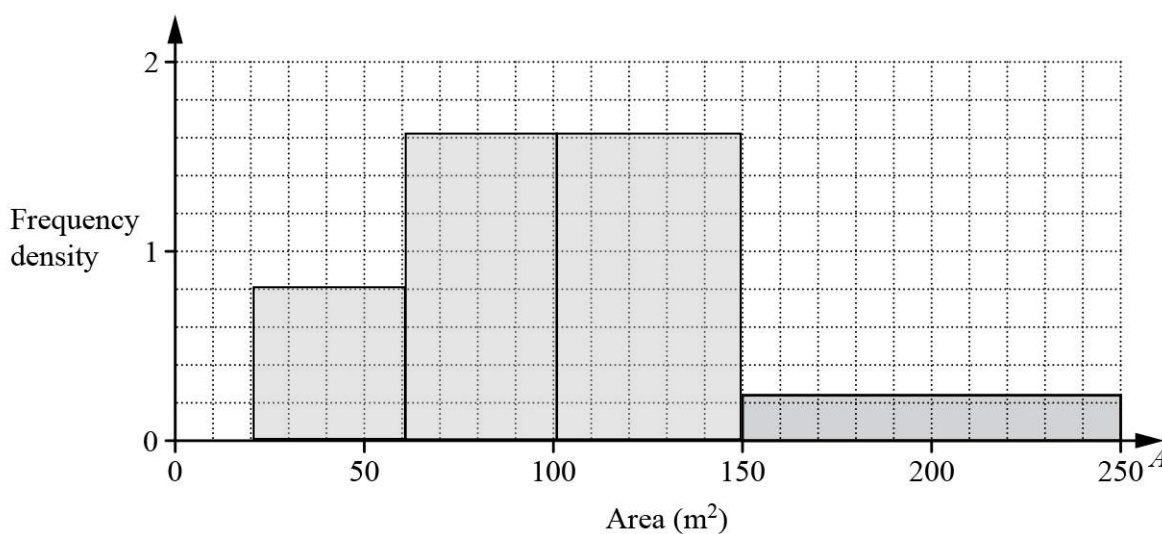

FD's 0.8, 1.6, 1.6

[4]

- (iii) Two students are chosen at random from those students that estimated the area of the windows to be more than  $100 \text{ m}^2$ .

Find the probability that one of the two students estimates the area to be greater than  $150 \text{ m}^2$  and the other student estimates the area to be  $150 \text{ m}^2$  or less.

$80 + 24 = 104$  estimated more than 100, 24 estimated more than 150

$$\text{Probability for one student} = \frac{24}{104}, \frac{80}{104}$$

$$\frac{24}{104} \times \frac{80}{103} + \frac{80}{104} \times \frac{24}{103}$$

$$\dots\dots\dots \frac{3840}{10\,712} \dots\dots\dots \text{ [3]}$$

## Examiner comment

### Question 2

- (a) (i) One mark for reading the median. Use the cumulative frequency scale and take reading at halfway (100). 1/1
- (ii) To find the interquartile range, find the upper quartile by taking a reading of the volume at the  $\frac{3}{4}$  point of the cumulative frequency (150th value = 420), and find the lower quartile by taking a reading of the volume at the  $\frac{1}{4}$  point of the cumulative frequency (50th value = 350). The interquartile range is the upper quartile minus the lower quartile. One mark is available for either the upper quartile or lower quartile written correctly. Candidates are advised to show their working on the graph and in the working space. 2/2
- (iii) To find the 60th percentile, find 60% of 200 (the total cumulative frequency). This is 120. Then take a reading of the volume from the graph for the 120th cumulative frequency value. Answers in the range 405 to 410 will be awarded the mark. 1/1
- (iv) This reading needs to be taken from the volume of 300 on the horizontal axis. Use the graph to find the cumulative frequency that corresponds to a volume of 300. This reading is the number of students who estimated the volume to be 300 m<sup>3</sup> or less. To find the number of students who estimated greater than 300, the reading must be subtracted from 200. 2/2
- (b) (i) To calculate an estimate of the mean, use the mid-interval values as an estimate for each interval and then find the sum of the product of the frequencies and the mid-interval values. This sum should then be divided by the total frequency (200) to find the mean. Method marks are awarded for showing the mid-interval values, finding the sum of the products and for the final division by 200. The answer is exact at three significant figures. Showing full working is important. 4/4
- (ii) To complete the histogram, the frequency densities for the first 3 intervals must be found. Divide the frequency by the width of the interval to find the frequency densities. The bars are then drawn to the heights of the frequency densities and have the same width as the class intervals. Pencils and rulers are important for accuracy, and when drawing the graph no gaps should be left between the bars. Part marks are available for correct bars, correct widths and frequency densities written. 4/4
- (iii) This question involves finding a conditional probability first. As 104 students estimated more than 100 m<sup>2</sup> and 24 students estimated more than 150 m<sup>2</sup>, the probability is  $\frac{24}{104}$  that one of these students estimated more than 150. It must be  $\frac{80}{104}$  that one student estimated less than 150.
- If two students are to be chosen then the second student is dependent on the first and there are two possibilities to consider: either the first student estimated more than 150, and the second student estimated less than 150; or the first student estimated less than 150, and the second student estimated more than 150. Both of these products need to be calculated and then added. Candidates need to be aware that after the first student is chosen, there are only 103 students left to choose from for the second choice. 3/3

**Total mark awarded = 17 out of 17**

## Question 3

### Specimen answer/s

3  $f(x) = \frac{20}{x} + x, x \neq 0$

(a) Complete the table.

$x$	-10	-8	-5	-2	-1.6		1.6	2	5	8	10
$f(x)$	-12	-10.5	-9	-12	-14.1		14.1	12	9	10.5	12

[2]

(b) On the grid, draw the graph of  $y = f(x)$  for  $-10 \leq x \leq -1.6$  and  $1.6 \leq x \leq 10$ .

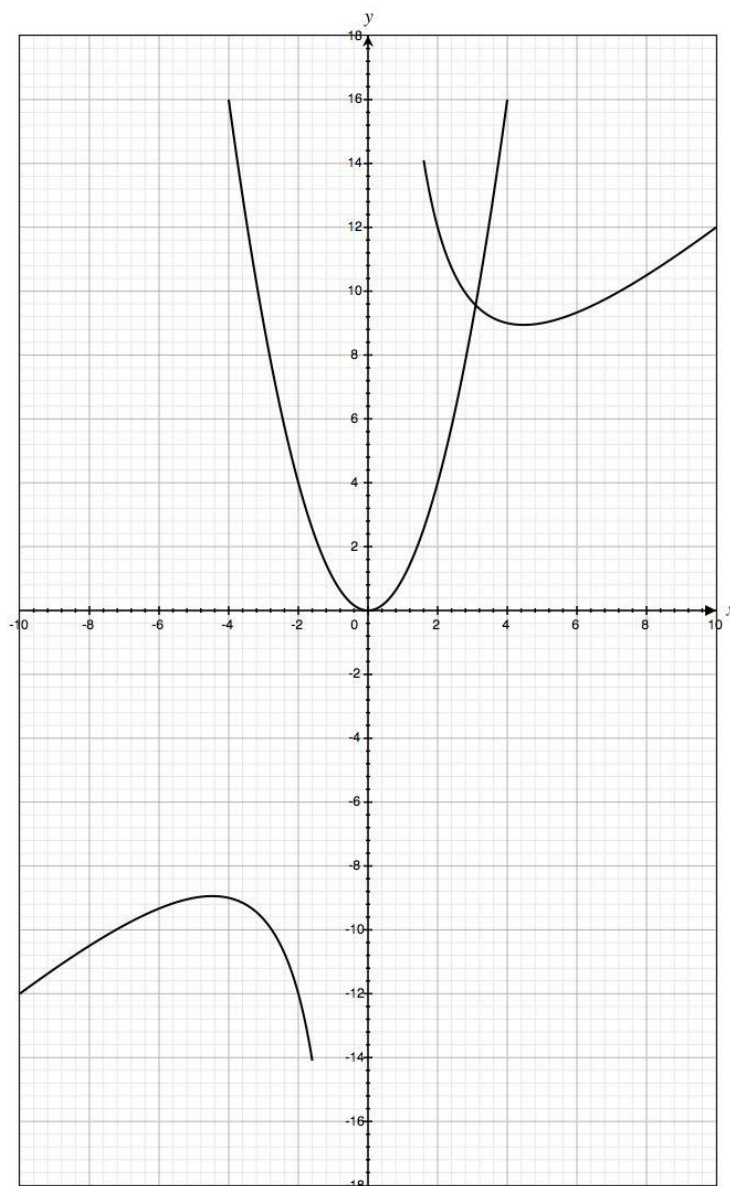

[5]

(c) Using your graph, solve the equation  $f(x) = 11$ .

$x = \underline{\quad 8.7 \quad}$  or  $x = \underline{\quad 2.4 \quad}$  [2]

(d)  $k$  is a prime number and  $f(x) = k$  has no solutions.

Find the possible values of  $k$ .

Draw horizontal line on graph to find any lines that do not cross curve in part (b). Which are prime?

$\underline{\quad 2, 3, 5, 7 \quad}$  [2]

(e) The gradient of the graph of  $y = f(x)$  at the point  $(2, 12)$  is  $-4$ .

Write down the coordinates of the other point on the graph of  $y = f(x)$  where the gradient is  $-4$ .

$(\underline{\quad -2 \quad}, \underline{\quad -12 \quad})$  [1]

(f) (i) The equation  $f(x) = x^2$  can be written as  $x^3 + px^2 + q = 0$ .

Show that  $p = -1$  and  $q = -20$ .

$$\frac{20}{x} + x = x^2$$

$$20 + x^2 = x^3$$

Collect on right hand side

$$0 = x^3 - x^2 - 20$$

Therefore  $p = -1$  and  $q = -20$

[2]

(ii) On the grid opposite, draw the graph of  $y = x^2$  for  $-4 \leq x \leq 4$ .

[2]

(iii) Using your graphs, solve the equation  $x^3 - x^2 - 20 = 0$ .

$x = \underline{\quad 3.3 \quad}$  [1]

(iv)

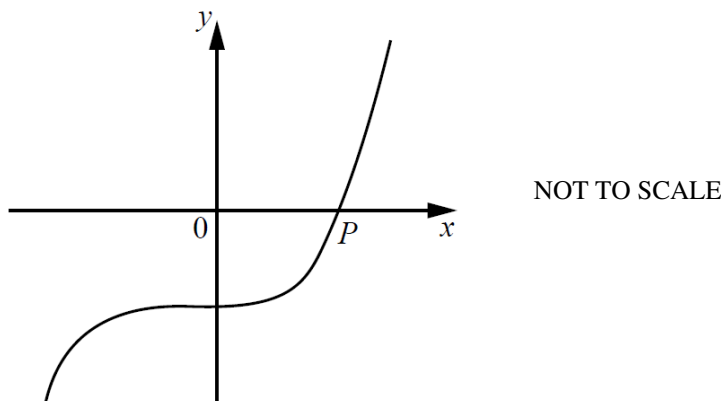

The diagram shows a **sketch** of the graph of  $y = x^3 - x^2 - 20$ .

$P$  is the point  $(n, 0)$ .

Write down the value of  $n$ .

$n = \underline{\quad 3.3 \quad}$  [1]

## Examiner comment

## Question 3

- (a) Use a calculator to substitute the  $x$ -values 5 and 8 into the given equation. Note that the table is shaded in the middle – this is an indication that there is no  $x=0$  value for the equation. **2/2**
- (b) The points from the table should be plotted as accurately as possible using a pencil. Accuracy required is within 1 mm for plots. Points should be joined with a smooth curve using a pencil. There are two branches to this curve and they should not be joined as  $x=0$  does not exist for this equation. **5/5**
- (c) Draw the line  $y=11$  on the graph and read the  $x$ -values of the points where the line  $y=11$  crosses the curve drawn in part (b). Remember to use a ruler to draw the line  $y=11$ . The line will cross the curve in two places; this is why the answer space is set up for two answers. Answers within the ranges 2.1 to 2.6 and 8.5 to 9 will be awarded marks. **2/2**
- (d) This is more searching.  $y=k$  is a horizontal line, so consider a horizontal line drawn on the grid that does not cross the curve drawn in part (b) at all. There will be a number of possible lines. From these lines, pick those that go through a prime number on the  $y$ -axis. That will give the required values 2, 3, 5, 7. **2/2**
- (e) This has to be done using the rotational symmetry of the curve and considering where the curve is the ‘same shape’ as at (2, 12) when rotated. **1/1**
- (f) (i) First, set up some algebra using the original equation  $f(x)$  and make this equal to  $x^2$ . Then multiply all of the terms by  $x$  to remove the fractions and then collect all of the terms on one side of the equation. **2/2**
- (ii) Work out, then plot points for  $y=x^2$  on the grid and then join them with a smooth curve. You should know what shape of graph  $y=x^2$  will produce before drawing it. Remember to use a pencil. **2/2**
- (iii) This is linked to part (f)(i) where  $f(x)$  was equal to  $x^2$  and was shown to be the same as the equation given here. Find the intersection of  $y=x^2$  and  $f(x)$  on your graph and write down the  $x$  value at this intersection. **1/1**
- (iv) This is also linked to part (i) and (iii). The value where this curve crosses the  $x$ -axis is at  $y=0$  and so the answer is the same as part (iii). **1/1**

**Total mark awarded = 18 out of 18**



## Question 4

### Specimen answer/s

4

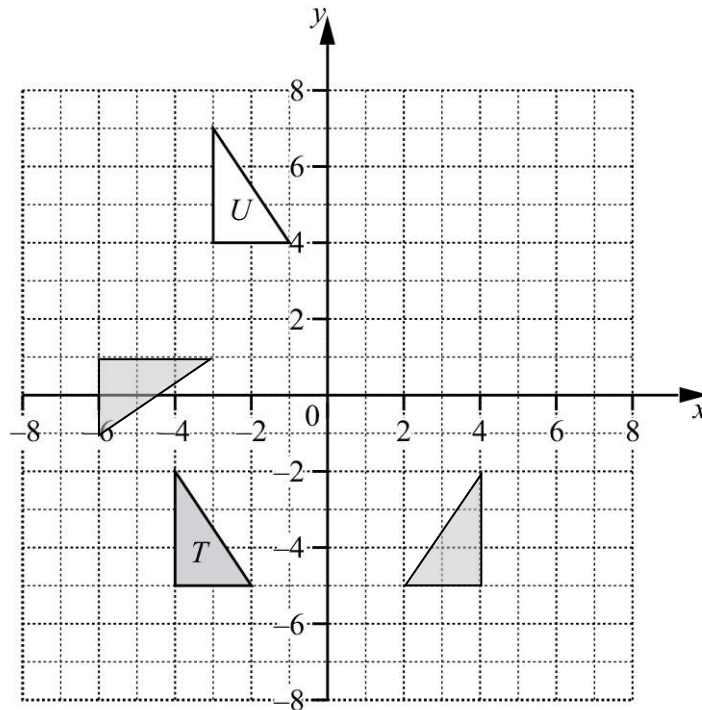

- (a) (i) Draw the reflection of triangle  $T$  in the line  $x = 0$ . [2]
- (ii) Draw the rotation of triangle  $T$  about  $(-2, -1)$  through  $90^\circ$  clockwise. [2]
- (b) Describe fully the **single** transformation that maps triangle  $T$  onto triangle  $U$ .

Translation by the vector

$$\begin{pmatrix} 1 \\ 9 \end{pmatrix}$$

[2]

### Examiner comment

#### Question 4

- (a) (i) The mirror line  $x = 0$  is the same as the  $y$ -axis. Count squares to the mirror line to fix each point on the reflection. Join the points with a ruler and pencil. 2/2
- (ii) To rotate, it is a good idea to use tracing paper to give an idea of where the image will be placed. This will be an approximation which can be checked by counting squares to the centre of rotation from each point on the image and each point on the original shape. 2/2
- (b) The question asks for a single transformation so it is really important to select one of translation, rotation, reflection or enlargement only. Once translation has been selected, describe the translation using a column vector. 2/2

**Total mark awarded = 6 out of 6**

## Question 5

### Specimen answer/s

5 (a)



NOT TO SCALE

The perimeter of the rectangle is 80 cm.

The area of the rectangle is  $A$  cm<sup>2</sup>.(i) Show that  $x^2 - 40x + A = 0$ .

$$\text{Length of rectangle} = \frac{A}{x}$$

$$\text{Perimeter: } x + x + \frac{A}{x} + \frac{A}{x} = 80$$

$$2x + \frac{2A}{x} = 80 \text{ multiply through by } x$$

$$2x^2 + 2A = 80x \text{ divide by 2}$$

$$x^2 + A = 40x$$

$$x^2 - 40x + A = 0$$

[3]

(ii) When  $A = 300$ , solve the equation  $x^2 - 40x + A = 0$  by factorising.

$$x^2 - 40x + 300 = 0$$

$$(x - 10)(x - 30) = 0$$

$$x = \underline{\quad 10 \quad} \text{ or } x = \underline{\quad 30 \quad} \quad [3]$$

(ii) When  $A = 200$ , solve the equation  $x^2 - 40x + A = 0$  using the quadratic formula.

Show all your working and give your answers correct to 2 decimal places.

$$x^2 - 40x + 200 = 0$$

$$x = \frac{40 \pm \sqrt{(-40)^2 - 4 \times 1 \times 200}}{2 \times 1} =$$

$$x = 5.857 \quad \text{and} \quad 34.142$$

$$x = \underline{\quad 5.86 \quad} \text{ or } x = \underline{\quad 34.14 \quad} \quad [4]$$



- (b) A car completes a 200 km journey at an average speed of  $x$  km/h.  
The car completes **the return journey** of 200 km at an average speed of  $(x + 10)$  km/h.

- (i) Show that the difference between the time taken for each of the two journeys is

$$\frac{2000}{x(x+10)} \text{ hours.}$$

$$\text{Time for journey} = \frac{200}{x}, \text{ time for return journey} = \frac{200}{x+10}$$

$$\frac{200}{x} - \frac{200}{x+10}$$

$$\frac{200(x+10) - 200x}{x(x+10)}$$

$$\frac{200x + 2000 - 200x}{x(x+10)}$$

$$= \frac{2000}{x(x+10)}$$

[3]

- (ii) Find the difference between the time taken for each of the two journeys when  $x = 80$ .  
Give your answer in **minutes** and **seconds**.

$$\frac{2000}{80(80+10)} = 0.27777777 \text{ hrs}$$

$$0.27777 \times 60 = 16.66666 \text{ mins}$$

$$16 \text{ mins and } 0.6666666 \times 60$$

$$\dots\dots\dots 16 \dots\dots \text{ min } \dots\dots\dots 40 \dots\dots \text{ s } [3]$$

## Examiner comment

### Question 5

- (a) (i) The information given in the question is about area and perimeter. The strategy is to write the length of the rectangle in terms of  $A$  and  $x$  and then to write an equation for the perimeter of the rectangle in terms of  $A$  and  $x$ . Once this is done, simplify the equation for the perimeter, step by step, to arrive at the given solution. Work vertically, line by line, and do not miss out any stage including the ' $= 0$ ' at the end. **3/3**
- (ii) Substitute 300 in place of  $A$  in the equation and then factorise the quadratic expression. Be careful with the signs as both factors have to be negative as the product is positive. Working must be shown to be awarded all three marks, as the question has directed candidates to use a particular method. **3/3**
- (iii) Substitute 200 in place of  $A$  in the equation and use the quadratic formula, as requested, to solve the equation. Best practice is to recall and write the formula first, before substituting in the values for  $a$ ,  $b$  and  $c$ . Remember to round answers to two decimal places, as requested, at the end. You must show all of your working to be awarded full marks. **4/4**
- (b) (i) This is a 'Show that' question which wants an expression for the difference in the times. First, obtain expressions for the times for the outward and return journeys from the given information, using the relationship: time = distance divided by speed. Then subtract the smaller time from the larger time algebraically, and then simplify the algebraic fractions by finding a common denominator and adjusting the numerators accordingly. As with all 'Show that' questions, show each step line by line and do not miss out any stage. **3/3**
- (ii) Substitute 80 into the expression in part (b)(i); this gives a time in hours. Convert to minutes by multiplying by 60 and remember if working with decimals to keep the full value on the calculator and do not round. To convert to seconds, multiply again by 60. **3/3**

**Total mark awarded = 16 out of 16**

## Question 6

### Specimen answer/s

6

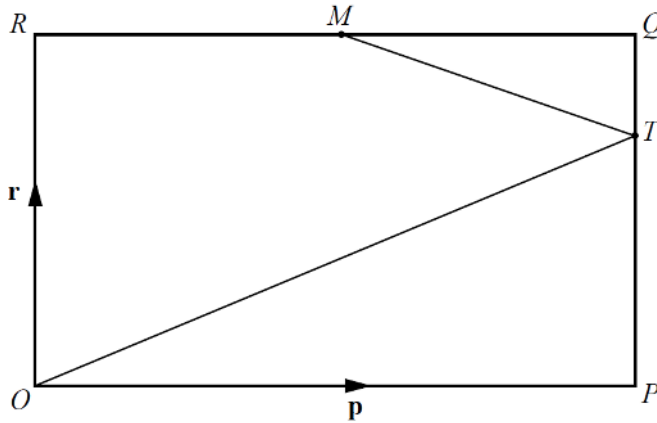

NOT TO  
SCALE

$OPQR$  is a rectangle and  $O$  is the origin.  
 $M$  is the midpoint of  $RQ$  and  $PT:TQ = 2:1$ .  
 $\vec{OP} = \mathbf{p}$  and  $\vec{OR} = \mathbf{r}$ .

(a) Find, in terms of  $\mathbf{p}$  and/or  $\mathbf{r}$ , in its simplest form

(i)  $\vec{MQ}$ ,

$$\vec{MQ} = \frac{1}{2}\mathbf{p} \quad [1]$$

(ii)  $\vec{MT}$ ,

$$\vec{MQ} + \vec{QT}$$

$$\vec{MT} = \frac{1}{2}\mathbf{p} - \frac{1}{3}\mathbf{r} \quad [1]$$

(iii)  $\vec{OT}$ ,

$$\vec{OP} + \vec{PT} = \mathbf{p} + \frac{2}{3}\mathbf{r}$$

$$\vec{OT} = \mathbf{p} + \frac{2}{3}\mathbf{r} \quad [1]$$

(b)  $RQ$  and  $OT$  are extended and meet at  $U$ .

Find the position vector of  $U$  in terms of  $\mathbf{p}$  and  $\mathbf{r}$ .  
 Give your answer in its simplest form.

Position vector is  $\vec{OU}$

$$\vec{OR} + \vec{RQ} + \vec{QU} = \mathbf{r} + \mathbf{p} + \frac{1}{2}\mathbf{p}$$

$$\vec{OU} = \mathbf{r} + \frac{3}{2}\mathbf{p} \quad [2]$$

(c)  $\vec{MT} = \begin{pmatrix} 2k \\ -k \end{pmatrix}$  and  $|\vec{MT}| = \sqrt{180}$ .

Find the positive value of  $k$ .

Find magnitude of vector in terms of  $k$

$$\begin{aligned} & \sqrt{(2k)^2 + (-k)^2} \\ &= \sqrt{4k^2 + k^2} \\ &= \sqrt{5k^2} \end{aligned}$$

$$\sqrt{5k^2} = \sqrt{180}$$

$$5k^2 = 180$$

$$k^2 = 36$$

$$k = \pm\sqrt{36} \text{ take positive answer only}$$

$$k = \underline{\hspace{2cm}6\hspace{2cm}} \quad [3]$$

## Examiner comment

### Question 6

(a) (i) As  $M$  is the midpoint of  $RQ$  and  $\vec{RQ} = \mathbf{p}$ ,  $\vec{MQ}$  will be half of  $\mathbf{p}$ . 1/1

(ii) Best practice is to always write the route down first, so  $\vec{MT} = \vec{MQ} + \vec{QT}$ . This gives  $\frac{1}{2}\mathbf{p} - \frac{1}{3}\mathbf{r}$  as  $\vec{QT}$  is in the opposite direction to  $\mathbf{r}$  and  $T$  divides  $QP$  in the ratio 1 : 2. 1/1

(iii) Again, write down the simplest route to get from  $O$  to  $T$  and then write this route in terms of  $\mathbf{p}$  and  $\mathbf{r}$ .  $\vec{PT}$  is  $\frac{2}{3}\mathbf{r}$  from the ratio 1 : 2. 1/1

(b) The first step is to understand the term ‘position vector’ and then find a route to get from  $O$  to  $U$ . Extending the diagram to  $U$  is good practice to help here. Once the route from  $O$  to  $U$  has been decided, write each vector in terms of  $\mathbf{p}$  and/or  $\mathbf{r}$ . The vector  $QU$  will be needed and this is the same as the vector  $MQ$ . Remember to give the answer as simply as possible at the end, as requested in the question. 2/2

(c) The key to getting started here is to understand the symbol used for magnitude  $|\vec{MT}|$ . So this question is about magnitude of vectors. Write the magnitude, using Pythagoras’ theorem, in terms of  $k$  for  $\vec{MT}$  and then form an equation in  $k$  with the actual magnitude of  $MT$ . Square both sides and then solve. The question asks for the positive value of  $k$  so select the positive answer from the square root. 3/3

**Total mark awarded = 8 out of 8**

## Question 7

### Specimen answer/s

7             $f(x) = 2x + 1$              $g(x) = x^2 + 4$              $h(x) = 2^x$

- (a) Solve the equation  $f(x) = g(1)$ .

$$\begin{aligned} g(1) &= 1^2 + 4 = 5 \\ f(x) &= 5 \\ 2x + 1 &= 5 \\ 2x &= 5 - 1 \\ 2x &= 4 \end{aligned}$$

$$x = \dots\dots\dots 2 \dots\dots\dots [2]$$

- (b) Find  $f^{-1}(x)$ .

$$\begin{aligned} x &= 2y + 1 \\ x - 1 &= 2y \\ \frac{x-1}{2} &= y \end{aligned}$$

$$f^{-1}(x) = \dots\dots\dots \frac{x-1}{2} \dots\dots\dots [2]$$

- (c) Find  $gf(x)$  in its simplest form.

$$\begin{aligned} (2x + 1)^2 + 4 \\ 4x^2 + 2x + 2x + 1 + 4 \\ 4x^2 + 4x + 5 \end{aligned}$$

$$\dots\dots\dots 4x^2 + 4x + 5 \dots\dots\dots [3]$$

- (d) Solve the equation  $h^{-1}(x) = 0.5$ .

Inverse of  $h = 0.5$  so  $x = 2$  to the power of  $0.5$

$$x = \dots\dots\dots \sqrt{2} \dots\dots\dots [1]$$

- (e)  $\frac{1}{h(x)} = 2^{kx}$

Write down the value of  $k$ .

$$\frac{1}{2^x} = 2^{-x}$$

$$k = \dots\dots\dots -1 \dots\dots\dots [1]$$

## Examiner comment

### Question 7

- (a) For this function problem, first of all work out  $g(1)$  by substituting 1 into function  $g$ . This gives an answer of 5. Then set up an equation with  $f(x) = 5$ , and finally solve to find  $x$ . **2/2**
- (b) The first stage is to understand that the notation  $f^{-1}(x)$  means the inverse of  $x$ . There are several ways of doing this. At some stage  $x$  and  $y$  have to interchange in the function. In this answer, this is done at the start. Then rearrange the function to find  $x$  in terms of  $y$ . **2/2**
- (c) This involves substituting function  $f$  into function  $g$ . Replace  $x$  in function  $g$  with  $(2x + 1)$  and ensure that this is bracketed when substituted in. Then expand the brackets and simplify the expression as far as possible. **3/3**
- (d) Although this looks complicated, it is worth one mark only and requires candidates to simply understand the 'effect' of an inverse function. An inverse reverses the effect of the original function and changes any value back to its original value. **1/1**
- (e) The first stage is to substitute  $2^x$  in place of  $h(x)$ . The fraction is then  $\frac{1}{2^x}$ , which is the same as  $2^{-x}$ , therefore  $k = -1$ . **1/1**

**Total mark awarded = 9 out of 9**

## Question 8

### Specimen answer/s

- 8 The grid shows the graph of  $y = \cos x$  for  $0^\circ \leq x \leq 360^\circ$ .

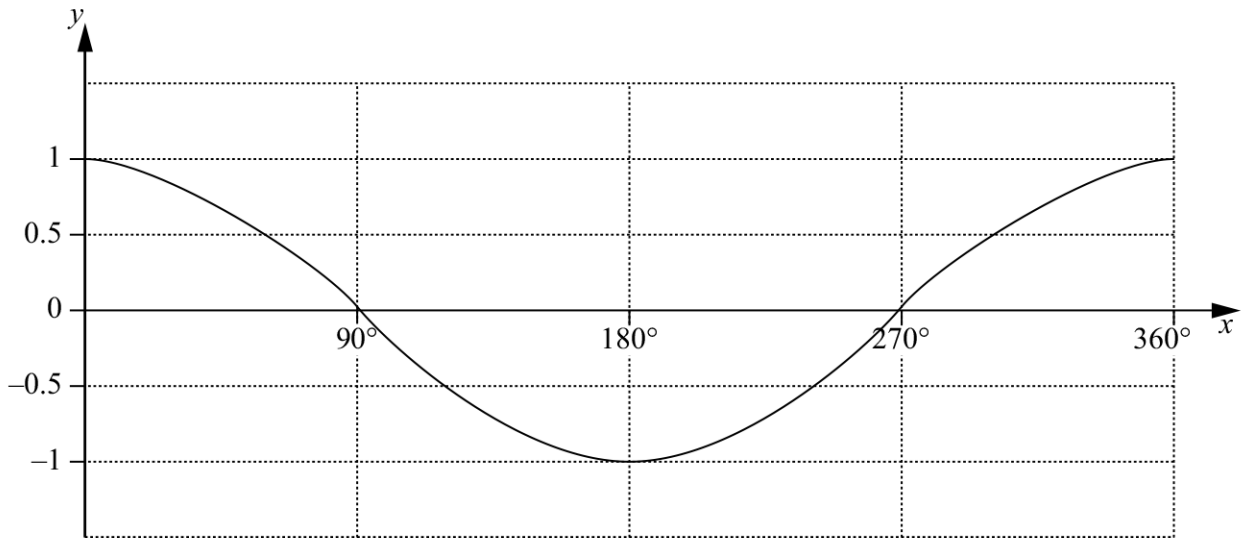

- (a) Solve the equation  $3\cos x = 1$  for  $0^\circ \leq x \leq 360^\circ$ .  
Give your answer correct to 1 decimal place.

$$\cos x = \frac{1}{3}$$

$$\cos^{-1}\left(\frac{1}{3}\right) = 70.529 = 70.5 \text{ to 1 dp}$$

$$360 - 70.6 = 289.5$$

$$\underline{\quad 70.5 \quad} \text{ and } \underline{\quad 289.5 \quad} \quad [4]$$

- (b) On the same grid, sketch the graph of  $y = \sin x$  for  $0^\circ \leq x \leq 360^\circ$ .

[2]

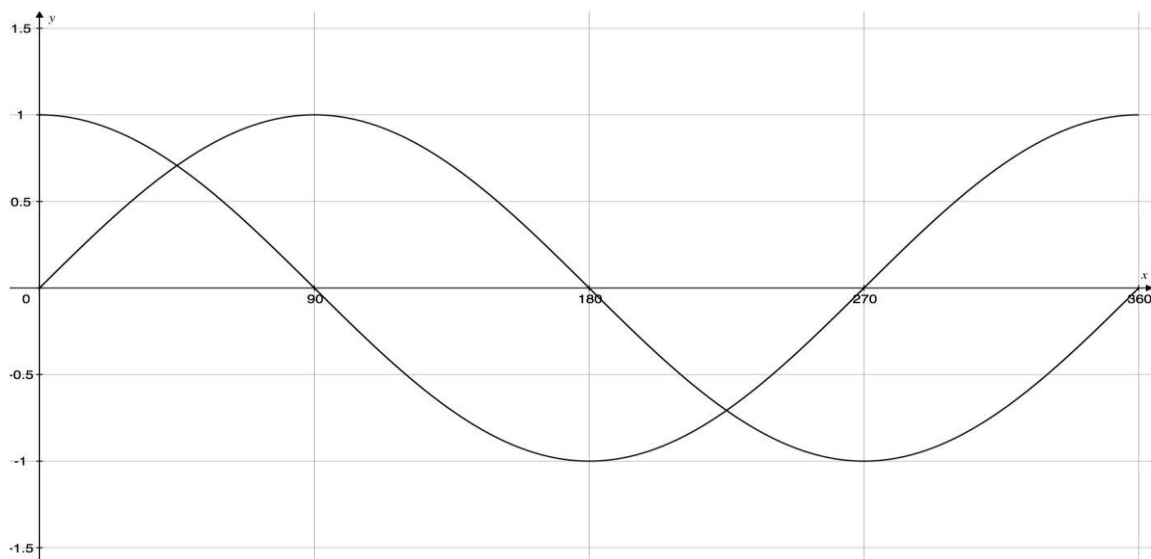

## Examiner comment

### Question 8

- (a) This is new syllabus content for 2020 and involves solving a simple trig equation. The first step is to divide by 3 to make  $\cos x$  the subject. Then take the inverse cos using a calculator to find the 'principal value'. The question gives a range 0 to 360 for the solutions, so now use the curve given to look for any other angles that have the same cosine value. From the symmetry of the curve, the other value is  $360 -$  the principal value. Remember to round both answers to one decimal place as requested. **4/4**
- (b) This is new syllabus content for 2020 and requires candidates to have knowledge of the sine graph. Candidates should know that the graph produces a wave with a period of  $360^\circ$  and an amplitude of 1, starting at  $(0, 0)$  and finishing at  $(360, 0)$  with a maximum at  $(90, 1)$  and a minimum at  $(270, -1)$ . The sketch should be freehand but should be clear enough to have the key points listed above in approximately the correct place. **2/2**

**Total mark awarded = 6 out of 6**



## Question 9

### Specimen answer/s

9

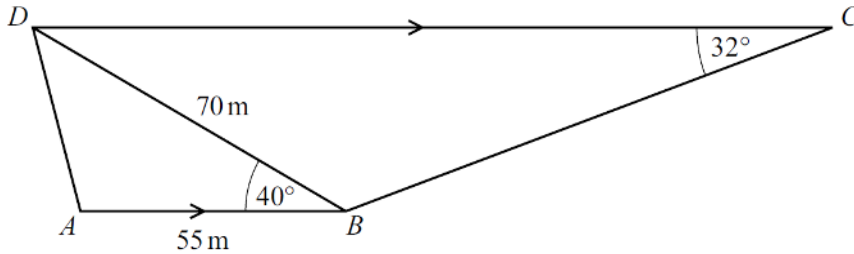

NOT TO SCALE

The diagram shows a trapezium  $ABCD$ .  
 $AB$  is parallel to  $DC$ .  
 $AB = 55$  m,  $BD = 70$  m, angle  $ABD = 40^\circ$  and angle  $BCD = 32^\circ$

(a) Calculate  $AD$ .

$$AD^2 = 55^2 + 70^2 - 2 \times 55 \times 70 \times \cos(40)$$

$$AD = \sqrt{2026.457788}$$

$$AD = 45.016 \dots$$

$$AD = \dots 45.0 \dots \text{ m [4]}$$

(b) Calculate  $BC$ .

$$\frac{BC}{\sin 40} = \frac{70}{\sin 32}$$

$$BC = \frac{70 \sin 40}{\sin 32} = 84.909 \dots$$

$$BC = \dots 84.9 \dots \text{ m [4]}$$

(c) Calculate the area of  $ABCD$ .

$$\frac{1}{2} \times 55 \times 70 \times \sin 40 + \frac{1}{2} \times 70 \times 84.909 \dots \times \sin(180 - 40 - 32)$$

$$= 4063.73017$$

$$\dots 4060 \dots \text{ m}^2 \text{ [3]}$$

(d) Calculate the shortest distance from  $A$  to  $BD$ .

Let shortest distance =  $AX$

$$\frac{AX}{55} = \sin(40)$$

$$AX = 55 \times \sin(40)$$

$$= 35.353 \dots$$

$$\dots 35.4 \dots \text{ m [2]}$$

## Examiner comment

## Question 9

- (a) This part requires candidates to decide on the most appropriate technique to use to find the missing length. As two sides and the included angle have been given, the cosine rule is the method to use.  
This requires careful recall of the formula, and then correct substitution of the values from the triangle. Once values have been substituted, the rest should be done on the calculator with no intermediate stage of rounding made. The final answer needs to be given correct to at least 3 significant figures. **4/4**
- (b) For this length, the sine rule is the most appropriate method, but first angle  $BDC$  needs to be found by using the parallel lines given in the diagram. Angle  $BDC$  is  $40^\circ$  because of alternate angles. The sine rule formula needs to be written and then correct substitution of the values from the triangle. There is one stage of manipulation to be done before the calculation can be completed. Give the answer correct to at least three significant figures. **4/4**
- (c) The area can best be calculated by considering the two triangles  $ABD$  and  $BCD$ . For triangle  $ABD$ , two sides and the included angle have been given so use the area formula  $\frac{1}{2}bc\sin A$  with these values. For triangle  $BCD$ , one length is given ( $BD$ ) and one length has been calculated in part (b)  $BC$ . The included angle  $CBD$  can also be found using angles in a triangle add up to  $180^\circ$  so again use  $\frac{1}{2}bc\sin A$  with these values before adding the two areas. Best practice is to use the unrounded value for  $BC$  in the calculation as this will give the most accurate answer. **3/3**
- (d) Candidates should know that the shortest distance from  $A$  to  $BD$  is the perpendicular from  $A$  to  $BD$ . This then forms a right-angled triangle from which this distance can be calculated using  $\sin 40^\circ$  as shown in the answer provided. **2/2**

**Total mark awarded = 13 out of 13**

## Question 10

### Specimen answer/s

- 10 (a) Show that the volume of a metal sphere of radius 15 cm is 14 140 cm<sup>3</sup>, correct to 4 significant figures.

[The volume,  $V$ , of a sphere with radius  $r$  is  $V = \frac{4}{3}\pi r^3$ .]

$$\begin{aligned}\frac{4}{3} \times \pi \times 15^3 &= 14\,137.2 \\ &= 14\,140\end{aligned}$$

[2]

- (b) (i) The sphere is placed inside an empty cylindrical tank of radius 25 cm and height 60 cm. The tank is filled with water.

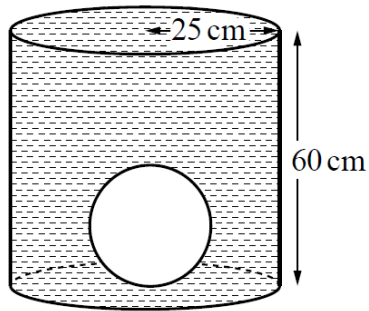

NOT TO  
SCALE

Calculate the volume of water needed to fill the tank.

$$\pi \times 25^2 \times 60 - 14\,140 = 103\,669.7$$

$$\dots\dots\dots 104\,000 \dots\dots\dots \text{cm}^3 \text{ [3]}$$

- (ii) The sphere is removed from the tank.

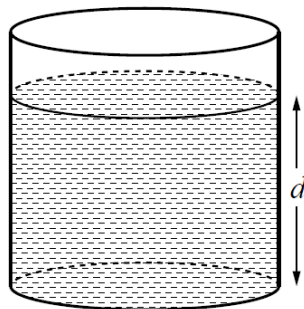

NOT TO  
SCALE

Calculate the depth,  $d$ , of water in the tank.

The volume of water is 103 669.7

$$\pi \times 25^2 \times d = 103\,669.7$$

$$d = \frac{103\,669.7}{\pi \times 25^2} = 52.7985\dots$$

$$d = \dots\dots\dots 52.8 \dots\dots\dots \text{cm} \text{ [2]}$$

- (c) The diagram below shows a solid circular cone and a solid sphere.

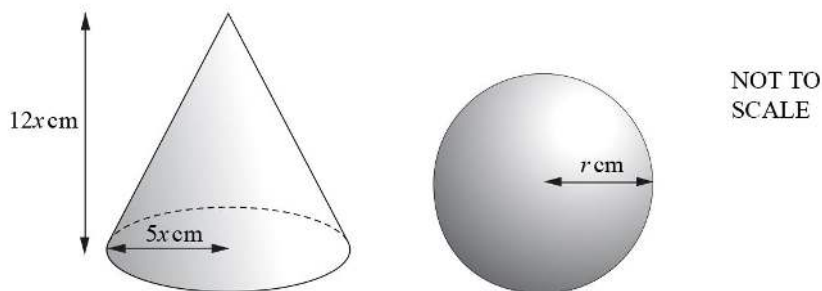

The cone has a radius  $5x$  cm and height  $12x$  cm.  
 The sphere has radius  $r$  cm.  
 The cone has the same **total** surface area as the sphere.

Show that  $r^2 = \frac{45}{2}x^2$ .

[The curved surface area,  $A$ , of a cone with radius  $r$  and slant height  $l$  is  $A = \pi rl$ .]

[The surface area,  $A$ , of a sphere with radius  $r$  is  $A = 4\pi r^2$ .]

Find the slant height for the cone using Pythagoras' theorem

$$\sqrt{(12x)^2 + (5x)^2} = 13x$$

$$\text{Total surface area of cone} = \pi \times 5x \times 13x + \pi \times (5x)^2 = 90\pi x^2$$

$$\text{Surface area of sphere} = 4\pi r^2$$

$$4\pi r^2 = 90\pi x^2$$

$$2r^2 = 45x^2$$

$$r^2 = \frac{45}{2}x^2$$

[5]

## Examiner comment

### Question 10

- (a) As this is a ‘Show that’ question, it is important that the full working is shown using the given formulae and the radius 15 cm. The calculated value to at least 5 significant figures is also required to justify the given answer.  
One mark for the substitution and a further mark for the more accurate answer. **2/2**
- (b)(i) This question requires candidates to recall the formula for the volume of a cylinder and then substitute the values for the radius and height into the formula. The volume of the sphere from part (a) needs to be subtracted from the volume of the cylinder. **3/3**
- (ii) Now that the sphere is removed, the volume of water will still be the same as that in part (b)(i). The shape of the water forms a cylinder.  
Set up an equation  $\pi \times 25^2 \times d = 103\,669.7$  where  $d$  is the height of the cylinder, then solve the equation to find  $d$ . Notice that a more accurate value for the volume has been used from part (b)(i) rather than just three significant figures to give a more accurate final answer. This is the best practice for candidates. **2/2**
- (c) The starting point is to use the given information to write expressions for the total surface area of the cone and the surface area of the sphere. The sphere is straightforward.  
The curved surface area of the cone needs the slant height to be calculated. This can be done using Pythagoras’ theorem with the vertical height and radius of the cone.  
The next stage is to consider the total surface area of the cone which is the curved surface area added to the base circle of the cone.  
Once the cone and sphere have been found, form an equation and simplify it to make  $r$  squared the subject. As this is a ‘Show that’ question remember to show each step of your working. **5/5**

**Total mark awarded = 12 out of 12**

## Question 11

### Specimen answer/s

11 A curve has equation  $y = x^3 - 6x^2 + 16$ .

(a) Find the coordinates of the two turning points.

Use the gradient function  $\frac{dy}{dx}$

$$\frac{dy}{dx} = 3x^2 - 12x$$

At turning points,  $\frac{dy}{dx} = 0$

$$3x^2 - 12x = 0$$

$$3x(x - 4) = 0$$

$$x = 0 \text{ or } x = 4$$

When  $x = 0$ ,  $y = 16$ ,

When  $x = 4$ ,  $y = 4^3 - 6 \times 4^2 + 16 = -16$

( 0 , 16 ) and ( 4 , -16 ) [6]

(b) Determine whether each of the turning points is a maximum or a minimum.  
Give reasons for your answers.

Using 2nd derivatives

$$\frac{d^2y}{dx^2} = 6x - 12$$

When  $x = 0$ ,  $\frac{d^2y}{dx^2} = -12$ , so this is a maximum as  $\frac{d^2y}{dx^2} < 0$

When  $x = 4$ ,  $\frac{d^2y}{dx^2} = 12$ , so this is a minimum as  $\frac{d^2y}{dx^2} > 0$

[3]

## Examiner comment

### Question 11

(a) This question tests the new syllabus area of derivatives and gradient functions.

The first step is to find the derivative  $\frac{dy}{dx}$  of the given function to give the gradient function.

At the turning points, the gradient function is equal to zero. So set up the equation and solve by factorising to find the two values of  $x$  at the turning points. To find the  $y$ -values, substitute these  $x$ -values into the original equation. This then gives the coordinates of the two turning points.

Method marks are earned throughout with two marks awarded for a correct expression for the derivative, and further part marks for equating to zero and solving to find the  $x$ -values. **6/6**

(b) There are two methods that can be used:

**Either:** Testing the gradient on either side of the turning point to establish the natures of the slope of the curve.

**Or:** Using the 2nd derivative (as shown in the model answer). Once the 2nd derivative has been

found, use the  $x$ -values at the turning points. If  $\frac{d^2y}{dx^2} < 0$  then this point will be a maximum, if  $\frac{d^2y}{dx^2} > 0$  then this is a minimum. **3/3**

**Total mark awarded = 9 out of 9**

Cambridge Assessment International Education  
The Triangle Building, Shaftesbury Road, Cambridge, CB2 8EA, United Kingdom  
t: +44 1223 553554 f: +44 1223 553558  
e: [info@cambridgeinternational.org](mailto:info@cambridgeinternational.org) [www.cambridgeinternational.org](http://www.cambridgeinternational.org)

© IGCSE is a registered trademark.  
Copyright © UCLES March 2018